



# CRYSTALLINE SILICON PV MODULE INSTALLATION GUIDE

# 1 Introduction

## 1.1 Purpose

This document provides detailed instructions and valuable safety information regarding the installation, electrical connection and maintenance of the JINNENG CLEAN ENERGY TECHNOLOGY LTD (Hereinafter referred to as " JINERGY " Crystalline Photovoltaic modules, involved module series are as follow Table 1:

Cell Size	Module Type
158.75	JNMP60/JNMM60/JNMP72/JNMM72/JNMP120/JNMP144
166	JNMM120/JNMM144/JNBM120/JNBM144/JNHM120/JNHM144
182	JNMM108/JNMN108/JNMN132/JNMN144/JNMM144 /JNBM144/JNBN144/JNBN156
210	JNMM120/JNBM120/JNMM132/JNBM132

Table 1

All instructions and mechanical and electrical requirements should be read and understood before attempting installation.

The installer should conform to all safety precautions in this guide when installing the module. Keep this guide in a safe place for further reference.

## 1.2 Limitation of Liability

Because the use of this manual and the conditions or methods of installation, operation, use and maintenance of photovoltaic (PV) products are beyond JINERGY control, JINERGY does not accept responsibility and expressly disclaims liability for loss, damage, or expense arising out of or in any way connected with such installation, operation, use or maintenance. JINERGY reserves the right to change the manual without prior notice.

## 1.3 Others

1.3.1 Modules rated for use in this application class may be used in systems operating at greater than 50V DC or 240W, where general contact access is anticipated. Modules qualified for safety through IEC 61730-1 and this part of IEC 61730 within this application class are considered to meet the requirements for safety class II.

1.3.2 Where common grounding hardware (nuts, bolts, star washers, spilt-ring lock washers, flat washers and the like) is used to attach a listed grounding/bonding device, the attachment must be made in conformance with the grounding device manufacturer's instructions.

# 2 Safety

## 2.1 General Safety

2.1.1 Consult and follow local codes and other applicable laws concerning required permitting as well as installation & inspection requirements, rules, and regulations.

2.1.2 PV modules should be installed and maintained by qualified personnel.

2.1.3 Use the same performance modules within a given series.

- 2.1.4 Follow all safety precautions of all components used in the system.
- 2.1.5 Do not shade portions of the PV module surface from the sun for a long period of time. The shaded cell will produce hot spot effect.
- 2.1.6 Do not clean the glass surface with chemicals.
- 2.1.7 Do not drop the PV module or drop objects onto the PV module.
- 2.1.8 Do not concentrate sunlight on the modules or panels.
- 2.1.9 Do not attempt to disassemble the modules, and do not remove any attached components from the modules.
- 2.1.10 Do not scratch or hit at the back sheet, the glass, the terminal box. Do not pull the cables or touch them with bare hands.
- 2.1.11 Do not drill holes in the frame or scratch the insulating coating of the frame.
- 2.1.12 Keep the PV module packed in the carton until installation and avoid carton moisture.
- 2.1.13 Do not use modules near equipment or in places where flammable gases may be generated.

## 2.2 Installation Safety

- 2.2.1 Wear protective head gear, insulating gloves, safety shoes, and insulated tools when installing the modules.
- 2.2.2 Do not install the modules in rain, snow, or otherwise wet or windy conditions.
- 2.2.3 Completely cover the PV module surface with an opaque material during PV module installation and wiring to prevent accidental charge buildup.
- 2.2.4 Plug in connectors tightly when working on wiring.
- 2.2.5 Due to the risk of electrical shock, do not perform any work if the terminals of PV module are wet.
- 2.2.6 Do not touch the terminal box and the end of output cables (connectors) with bare hands.
- 2.2.7 Do not unplug the connector under load.
- 2.2.8 Do not work alone.
- 2.2.9 Wear a safety belt if working far above the ground.
- 2.2.10 Do not wear metallic jewelry, which can cause electric shock, while installing or troubleshooting the PV system.
- 2.2.11 Follow the safety regulations for any and all other system components, including wires, connectors, charging regulators, batteries, inverters, etc.
- 2.2.12 Do not expose wires to direct sunlight. Use UV-resistant cabling.
- 2.2.13 Do not damage the surrounding PV modules or mounting structure when replacing a PV module.
- 2.2.14 Do not change any PV module components (diode, junction box, plug connectors, etc.).
- 2.2.15 Maximum reverse current for module is shown in Table 2. Use a blocking diode and maximum series overcurrent protective device in the combiner box are recommended for reverse current protection when more than three strings are connected in parallel.









Cell Size	Module Type	
	Single Glass	Double Glass
158.75	27A	27A



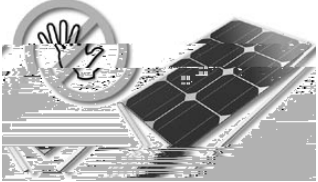

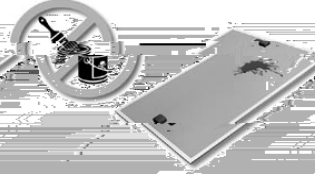





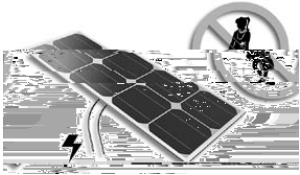

166	27A	27A
182	33.75A	40.5A
210	40.5A	47.25A

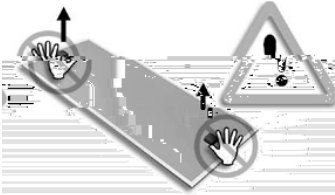
Table 2

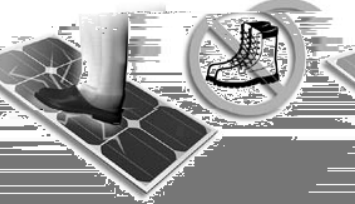
- 2.2.16 The solar modules are recommended to be installed over a fireproof and insulating roof covering when installed on a roof.
- 2.2.17 Module may not be contacted during working.
- 2.2.18 Please fixed the connecting cable to the bracket which avoid loose cable waggle.
- 2.2.19 It is forbidden to cable placed on the sharp edges.
- 2.2.20 The corresponding protection measures should be made for cable to prevent direct contact with animals.
- 2.2.21 Excess gas that battery produced could cause explosion.

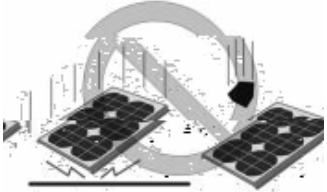
### 2.3 Installation matters needing attention

	 <p>Solar module (hereinafter referred to as the "components") under the sun can produce more than 30V voltage. The voltage exceeds the safety voltage range. So the electrical connection parts such as improper operation which sparks cause fire, electric shock, and even, so regardless of the component in any case, don't direct contact with the terminal.</p>
	 <p>Module for outdoor use, can be installed on the roof, vehicles, ships, etc. Installed in different attachments should be used for mounting bracket. Do not remove or moving components of any such as frame, glass, label, junction box adhesion on the module parts.</p>
	 <p>Don't attempt to daub on the surface of the module or paste any object.</p>
	 <p>Do not use a mirror, lens, or similar articles focus sunlight onto the module.</p>

	 <p>In the process of transportation and installation of module, please do not let the child contact and away from modules and solar photovoltaic power generation systems.</p>
	 <p>Do not place the module in the combustible gas easy generation or congregate.</p>
	 <p>In the process of moving module, do not grab junction box and cable, should contact the module frame for handling.</p>
	 <p>In any case, please don't trample modules.</p>
	 <p>To protect the glass is damaged, please do not place heavy objects on the module or throwing have damage to any of the items out of modules.</p>
	 <p>Careful handling, avoid knock against. Improper handling and placement, may cause module of glass breakage and loss of performance, which affects the output.</p>

### 3 Mechanical Installation

#### 3.1 Installation Condition

3.1.1 Environment temperature: -40 to 85

3.1.2 Operating temperature: -40 to 85

3.1.3 The maximum altitude of the PV module is designed: 2000m.

3.1.4 Tilt Angle selection: The installation should be facing north in the southern hemisphere and facing south in the northern hemisphere.

3.1.5 To maintain the modules' Class C fire rating, the fire class of the roof and building materials should be higher than Class C. The fire rating of this module is valid only when mounted in the manner specified in the mechanical mounting instructions.

3.1.6 Raise the distance when installation requirement is greater than or equal to 0.3 m. Module installation use appropriate installation angle, refer to the following Table 3.

Local latitude	Installation angle
0°~15°	15°
15°~25°	latitude
25°~30°	latitude+5°
30°~35°	latitude+10°
35°~40°	latitude+15°
40°	latitude+20°

Table 3

### 3.2 Installation method and corresponding static load

#### 3.2.1 Screw fixed installation method and static load

##### 1 158.75 Module

Screw installation method	
	
Installation of mounting beam through long side four hole bolt	
Static load	Test load
Module Type	Installation Method
JNMM60-XXX	Installation of mounting beam through long side four hole bolt
JNMM72-XXX	+5400Pa/-2400Pa
JNMP60-XXX	+5400Pa/-2400Pa
JNMP72-XXX	+5400Pa/-2400Pa
JNMP120-XXX	+5400Pa/-2400Pa
JNMP144-XXX	+5400Pa/-2400Pa

Table 4

##### 2 166 Module

Screw installation method		
		
Installation of mounting beam through long side inner four hole bolt	Installation of mounting beam through long side outer four hole bolt	
Static load Test load		
Module Type \ Installation Method	Installation of mounting beam through long side inner four hole bolt	Installation of mounting beam through long side outer four hole bolt
JNMM144-XXX	+5400Pa/-2400Pa	+5400Pa/-2400Pa
JNMM120-XXX	+5400Pa/-2400Pa	+3600Pa/-2400Pa
JNBM144-XXX	+3600Pa/-2400Pa	+5400Pa/-2400Pa
JNBM120-XXX	+5400Pa/-2400Pa	+5400Pa/-2400Pa
JNHM144-XXX	+3600Pa/-2400Pa	+5400Pa/-2400Pa
JNHM120-XXX	+5400Pa/-2400Pa	+5400Pa/-2400Pa

Table 5

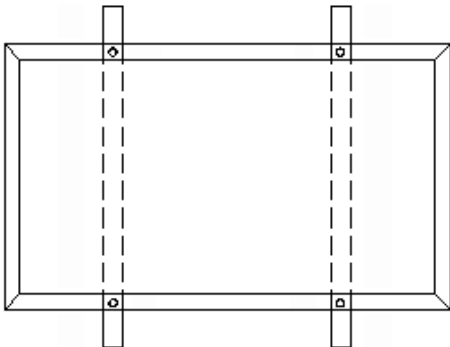
3 182 Module

Screw installation method		
		
Installation of mounting beam through long side inner four hole bolt	Installation of mounting beam through long side outer four hole bolt	
Static load Test load		
Module Type \ Installation Method	Installation of mounting beam through long side inner four hole bolt	Installation of mounting beam through long side outer four hole bolt
JNMM144-XXX	+5400Pa/-2400Pa	+5400Pa/-2400Pa
JNMM120-XXX	+5400Pa/-2400Pa	+3600Pa/-2400Pa
JNBM144-XXX	+3600Pa/-2400Pa	+5400Pa/-2400Pa
JNBM120-XXX	+5400Pa/-2400Pa	+5400Pa/-2400Pa
JNHM144-XXX	+3600Pa/-2400Pa	+5400Pa/-2400Pa
JNHM120-XXX	+5400Pa/-2400Pa	+5400Pa/-2400Pa

JNMM108-XXX	+5400Pa/-2400Pa	+2400Pa/-2400Pa
JNMN108-XXX	+5400Pa/-2400Pa	+2400Pa/-2400Pa
JNMN132-XXX	/	+5400Pa/-2400Pa
JNMN144-XXX	/	+5400Pa/-2400Pa
JNMM144-XXX	/	+5400Pa/-2400Pa
JNBM144-XXX	/	+5400Pa/-2400Pa
JNBN144-XXX	/	+5400Pa/-2400Pa
JNBN156-XXX	/	+5400Pa/-2400Pa

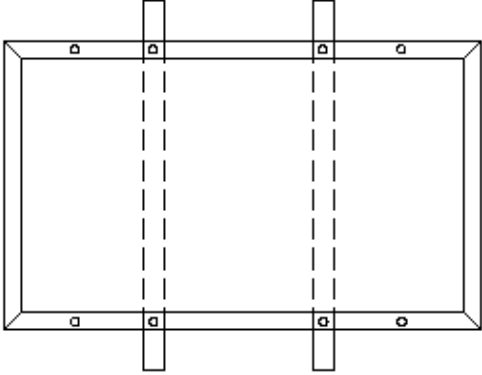
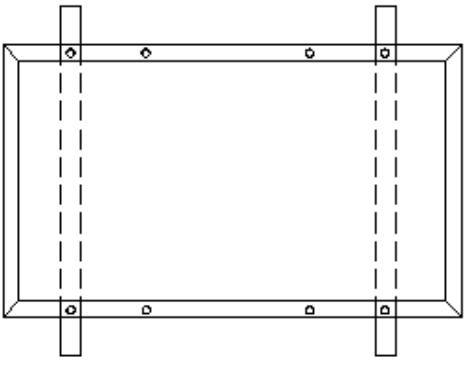
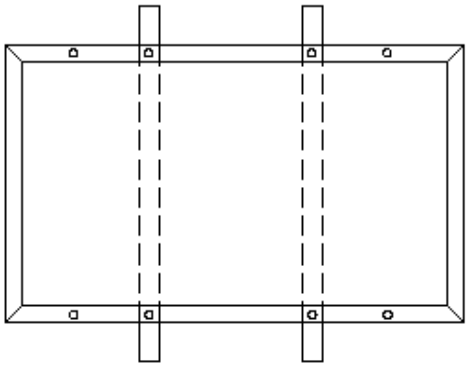
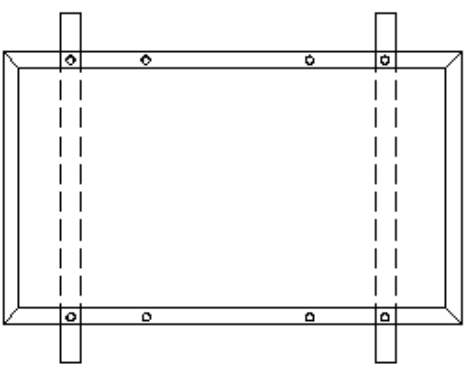
Table 6

4 210 Module

Screw installation method	
	
Installation of mounting beam through long side outer four hole bolt	
Static load    Test load	
Installation Method	Installation of mounting beam through long side outer four hole bolt
Module Type	
JNMM120-XXX	+5400Pa/-2400Pa
JNBM120-XXX	+5400Pa/-2400Pa
JNMM132-XXX	+5400Pa/-2400Pa
JNBM132-XXX	+5400Pa/-2400Pa

Table 7

Bolts are inserted as described in the process below (Fig. a).

1. Place the module on the supporting bars underneath (The modules should directly touch with the supporting bar). Insert the four stainless-steel bolts (M8) through the holes in the frame. Components must be laid across support rods (40mm to 80mm in width).
2. Secure each bolt to the frame with 2 stainless-steel washers, one on each side of the mounting structure; and screw on either a stainless-steel spring washer or a toothed lock washer. Finally, secure with a stainless steel nut (M8).



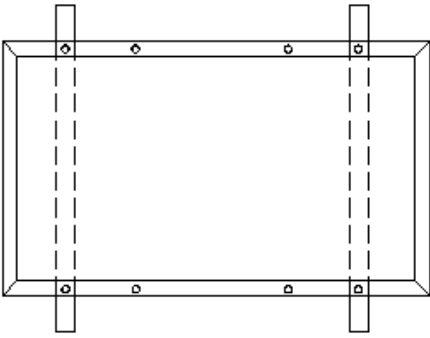
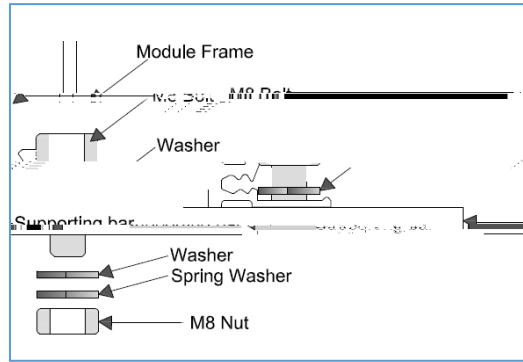

Fig. a

3. The torque for tightening the nut and bolts recommended 13Nm when the property class of bolts and nuts is Class 8.8.

### 3.2.2 Fixture fixed installation method and static load

#### 1 158.75 Module

Fixture fixed installation method(mm)			
<p>Installation of long side four pressing blocks embedded in beam</p>	<p>Installation of mounting beam through long side four pressure blocks</p>	<p>Installation of mounting beam through short side four pressure blocks</p>	
Static load Test load			
Installation Method Module Type	Installation of long side four pressing blocks embedded in beam	Installation of mounting beam through long side four pressure blocks	Installation of mounting beam through short side four pressure blocks
JNMM60-XXX	+5400Pa/-2400Pa	+5400Pa/-2400Pa	+2000Pa/-2000Pa
JNMM72-XXX	+5400Pa/-2400Pa	+5400Pa/-2400Pa	+1800Pa/-1400Pa
JNMP60-XXX	+5400Pa/-2400Pa	+5400Pa/-2400Pa	+2000Pa/-2000Pa
JNMP72-XXX	+5400Pa/-2400Pa	+5400Pa/-2400Pa	+1800Pa/-1400Pa
JNMP120-XXX	+5400Pa/-2400Pa	+5400Pa/-2400Pa	+2000Pa/-2000Pa
JNMP144-XXX	+5400Pa/-2400Pa	+5400Pa/-2400Pa	+1800Pa/-1400Pa

Table 8

#### 2 166 Module

Fixture fixed installation method(mm)

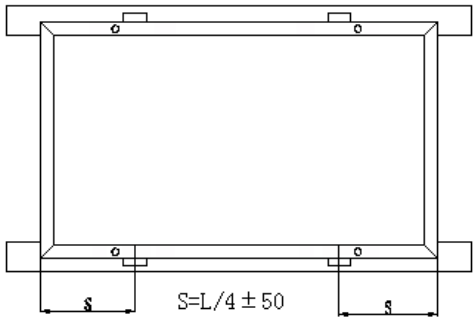
 <p>Installation of long side four pressing blocks embedded in beam</p>	<p>Installation of mounting beam through long side with 400 spacing four pressure blocks</p>			
<p>Installation of mounting beam through long side four pressure blocks</p>	<p>Installation of mounting beam through short side four pressure blocks</p>			
<p>Static load Test load</p>				
<p>Installation Method</p> <p>Module Type</p>	<p>Installation of long side four pressing blocks embedded in beam</p>	<p>Installation of mounting beam through long side with 400 spacing four pressure blocks</p>	<p>Installation of mounting beam through long side four pressure blocks</p>	<p>Installation of mounting beam through short side four pressure blocks</p>

Installation of mounting beam through long side four pressure blocks	
Static load    Test load	
Installation Method Module Type	Installation of mounting beam through long side four pressure blocks
JNMM108-XXX	+5400Pa/-2400Pa
JNMN108-XXX	+5400Pa/-2400Pa
JNMN132-XXX	+5400Pa/-2400Pa
JNMN144-XXX	+5400Pa/-2400Pa
JNMM144-XXX	+5400Pa/-2400Pa
JNBM144-XXX	+5400Pa/-2400Pa
JNBN144-XXX	+5400Pa/-2400Pa
JNBN156-XXX	+5400Pa/-2400Pa

Table 10

4 210 Module

Fixture fixed installation method(mm)
Installation of mounting beam through long side four pressure blocks
Static load    Test load

JNBM132-XXX	+5400Pa/-2400Pa
-------------	-----------------

Table 11

Each aluminum mounting clamp comes with an M8 bolt, a plain washer, a spring washer, and an M8 nut. To fasten the module:

1. Place the module on the two supporting bars (not provided). The bars should be made with stainless material or treated with an anti-corrosion process (e.g., anodic oxidation treatment). The component must be parallel or laid across support rods (the width of the support rod is 40-80 mm).
2. The bar's top surface contacted with module frame should come with grooves compatible with an M8 bolt.
3. If the bars do not come with grooves, holes of a suitable diameter may need to be drilled to allow bolts to be attached to the bars at the same locations as mentioned before.
4. Secure each clamp by attaching plain washer, spring washer, and nut, in that order.
5. Both of close-ups of Fig. b indicate the middle clamps and Fig. c indicate the side clamps for your reference. The dimensions for the middle clamps are

0

and  $\varnothing = 9$  mm. The torque for tightening the nut and bolts recommended 28Nm when the property class of bolts and nuts is Class 8.8. Especially the installation method of mounting beam through long side bracketting, slide bolts through groove on the supporting bars next to the locations where the clamps are to be fastened. The module may be clamped only in the permitted clamping area as on the long edge of the frame, and the edge of the clamp should not coincide with the position of the mounting hole.

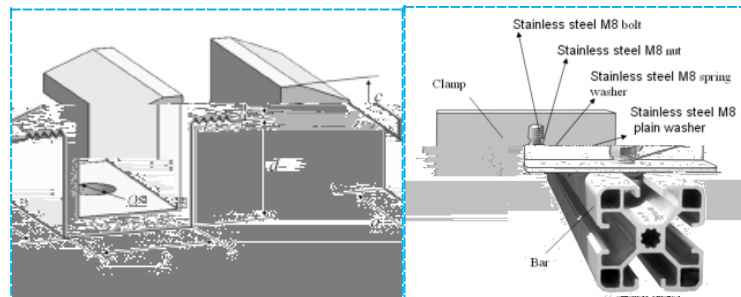
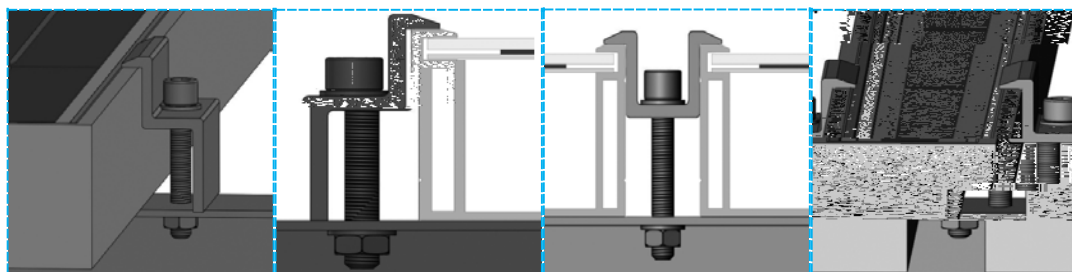

Fig. b

Fig. c



End Clamp installation

Middle Clamp installation

6. Especially the installation of long side pressing blocks embedded in beam, the modules may be mounted using clamps designed for solar modules refer to Fig.d, the modules must be supported along the length of the long edge and should overlap the array rail by 10mm-14mm.

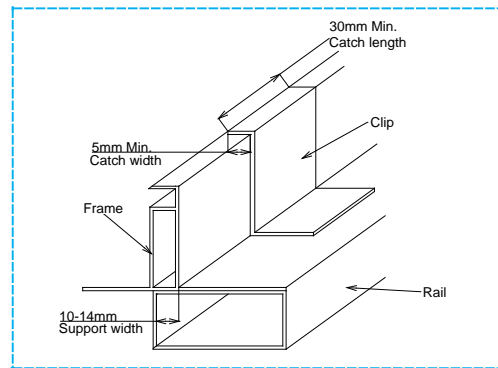

Fig. d

### 3.3 Stent

1. Please obey the instructions and safety regulations on racks. From bracket suppliers if necessary, can obtain more information on support.
2. Module frame provided on the back of at least 4 fixed hole used for fixed installation, please don't in the module of drilling hole on aluminum alloy frame, such as drilling, is likely to affect the service life of module.
3. Module must be installed in the frame of the plane. Entire squadron composed of modules and support system must be able to withstand the wind and snow load must produce mechanical stress.
4. A stent of heat bilges cold shrink stress should not impact on the performance of the module and use.
5. Stent must by weather resistance, corrosion resistance, UV resistance materials, gene.5 ( )JT0 Tc 0 Tw 1.b

and insulation.

5. In strong winds weather condition, please do not install the modules.

## 4 Electrical Installation

We recommend that all wiring and electrical connections comply with the appropriate national electrical code.

### 4.1 Installation

4.1.1 Under standard test conditions (1000W/m<sup>2</sup> irradiance, AM 1.5 spectrum, and cell temperature at 25°C (77°F)), electrical performance parameters of module refer to the module specifications.

4.1.2 The maximum system voltage for all module series is 1000V/1500V.

4.1.3 5.5 6 (m)padd.5

other DC electrical module.

It is recommended to calculate according to the following formula:

$$N \leq \frac{V_{dc\ max}}{V_{oc} \times [1 + (t - 25) \times K_v]}$$

N Recommended maximum number of series

$V_{dc\ max}$  Maximum system voltage DC1000V/1500V

$V_{oc}$  Refer to the values in the specification

t The lowest predicted local temperature

$K_v$  Open circuit voltage temperature coefficient

4.1.10 It is possible to heat or burn up except for hearing “ka” when people plug the connector.



Fail



Pass

4.1.11 The minimum bended radius is 43mm and prohibit to excessively bend. After the assembly is installed, the cable shall be fixed in time, and the cable shall not swing back and forth for a long time.

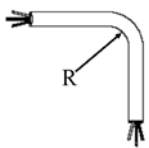

Fail



Pass



Fail



Pass

Bending radius of cable

4.1.12 It is recommended to use jinergy type PV-JN01, 5.6~6.3 mm cable for connector which supplied by module factory, these connectors are not recommended to replace the module connector.

4.1.13 Wiring mode of junction box

1 Wiring mode for vertical installation

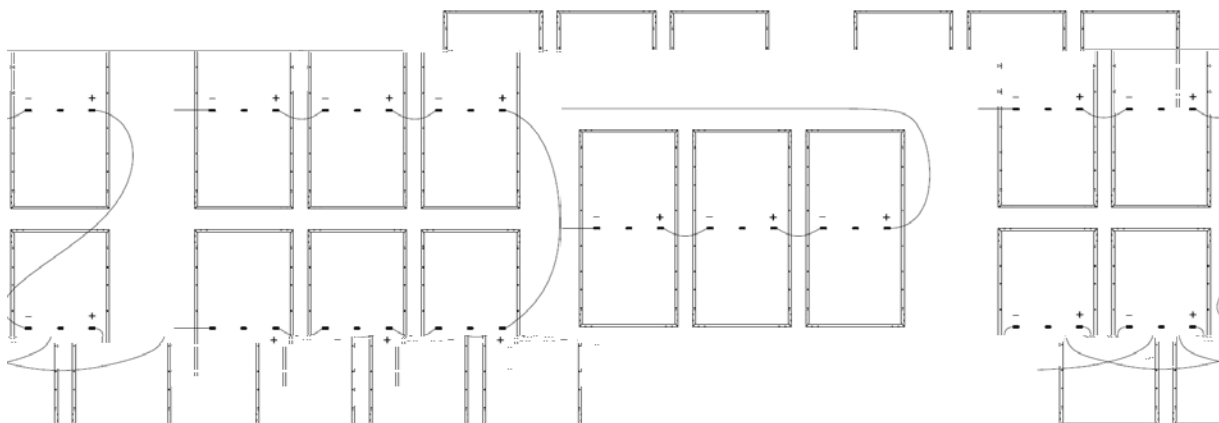

## 2 Wiring mode for horizontal installation

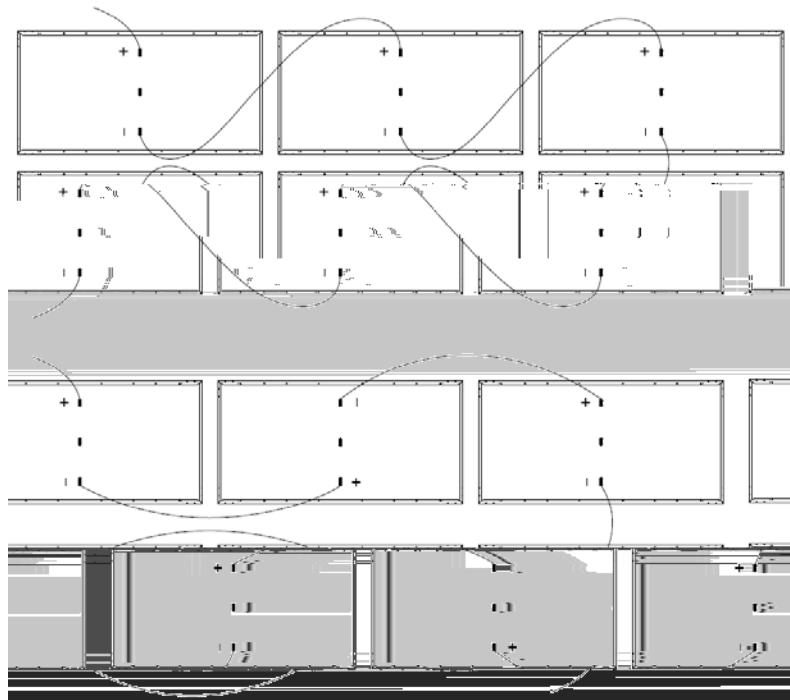

### 4.2 Grounding anti-thundered

#### 4.2.1 Grounding

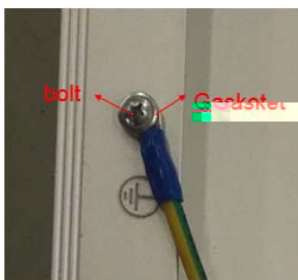
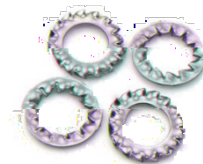

Fig.e



Toothed washer



nut

- 1) Use the marked 5.5 mm grounding holes (5.5mm) to ground the anodized frame. All nuts, bolts, and gasket are type M5 and should be made of stainless steel (Fig. e).
- 2) Put the bolt through the Fixed end and then through the hole in the aluminum frame.
- 3) Add the gasket and nut on the other side of the bolt and tighten to secure all parts. The tightening torque should be  $2.1 \pm 0.1 \text{ Nm}$ . (Note that the copper wire cannot be attached directly to the aluminum.).

To suggest grounding method above, also can use in line with the national electrical grounding method of relevant norms.

#### 4.2.2 Precautions for grounding anti-thundered

Conventional grounding hardware (nuts, bolts, washers, toothed lock washers, smooth washers, etc.) is used to connect grounding or securing equipment. The connection must comply with the grounding equipment manufacturer's instructions. When grounding, observe the following local standards and rules:



- 1) Use the ground hole on the frame for grounding. Do not use mounting holes or drill extra holes for grounding on the frame. Otherwise, the rigidity of the frame may be insufficient.
- 2) The frame is a corrosion-resistant coated aluminum frame. When grounding, it is necessary to use toothed gasket or self-tapping screw to penetrate the film to achieve a good grounding effect, otherwise it may cause poor grounding.
- 3) Each module is grounded individually. For example, ensure that all modules of series are properly connected at the beginning and end of each string. Do not ground one part in a single array.
- 4) The material, shape, size, buried depth, and grounding mode of the grounding body must comply with the design specifications.
- 5) Before the thunderstorm season, check whether the grounding of the PV module is reliable, such as whether the grounding cable is connected effectively and whether the anti-corrosion treatment measures are intact. If necessary, dig the ground to spot check the corrosion of the underground part.
- 6) The recommended grounding cable diameter must meet grounding requirements.
- 7) Anti-thundered measure should be taken to module series Photovoltaic grounding and lightning protection should implement by regulation of DL/T1364.

## 5 Installation method

1. The modules which installed at one series should be same power same color same current.
2. If the modules must be gathered together, we suggest that the first mix colors, secondly mix current, mixed power is not recommended.
3. Only high current modules can mixed into low current modules series.
4. The strapping tape of cable need to use scissors to cut open, can't catch the connector pull off.
5. If there is tape to hold the cables on the backsheet, remove it before installation.
6. During installation, the backsheet of the modules shall not be scratched.
7. Do not tread module in any case.
8. Where there are sandstorm, the module connector should immediately connect after a short period, or do sand protection, avoid sand enter into the connector and affect the installation.
9. Recommendations for coastal applications of PV modules (Table 13).

Definition	Coast Distance L(m)	Installation	Rack Requirement
General Location		Normal	Standard
Coast Location	$100 < L < 1000$	Anti-corrosive treatment	Anti-corrosive treatment
Severe Coast area	L	Reject	-

Table 13

- 1) All requirements in the installation manual must be followed.
- 2) The below instructions must be followed
  - a. Don't scratch Corrosion resistant layer with the surface of modules and PV system



b. All of support systems for PV installation, must be resistance to salt mist and corrosion of sea

3. For stubborn dirt on the glass surface, you can use mild, non-abrasive cleaners, such as glass cleaners, alcohol, etc., and do not use corrosive chemical reagents.
4. People can clear it with soft items if there is thick snow on the glass, be careful to not scratch glass. It is not recommended to clean when the snow wait to be too thick, to avoid the module surface freeze.
5. Do not clean the module which glass is cracked or cable is damaged, as there is a risk of electric shock.
6. Don't walking, standing or sitting on the module to clean.



7. It is not recommended to clean with higher mineral water because there are remaining minerals after dry up.
8. It is forbidden to clean with water which temperature is different largely with module otherwise the glass is impossible to broken.
9. Do not touch the surface of module with bare hands.

### 6.3 Safety tips





1. It is recommended that professional personnel check and maintain the power station system to avoid electric shock or personal injury.
2. Pay attention to safety protection measures during inspection and maintenance. Electrical equipment may be in high voltage danger.
3. Follow the operation and maintenance instructions and safety rules for all components used in PV system.

## 7 Unloading and storage of modules



### 7.1 Unloading

1. Horizontal - container loading

S/N	Operating Procedure	Photo	Control Point
-----	---------------------	-------	---------------

1	If the container is on the ground, the module can be unloading directly.		<p>If the container is not full the people need to cut the bandage when unloading (If the container is full the bandage is none).</p> 
2	If the container is on the flatbed trailer, the module need a landing platform when unloading.		<ol style="list-style-type: none"> <li>1. Before the forklift operate, add some buffer articles at the forklift arm to avoid damaging the module.</li> <li>2. Box transportation needs to keep horizontal or tilted to the direction of forklift.</li> <li>3. The vertical surface of the forklift arm should be smooth and there are no something that sticks out.</li> <li>4. Start from the short side of the packing box, reduce modules that are broken.</li> <li>5. When second transportation, a special person should be command to carry, and it is prohibited to damage the packing box.</li> <li>6. During operation, the forklift truck should not hit the pallet including the pallet wooden pier.</li> </ol>
3	The forklift can loading 3T or more, raising the module smoothly pull out and keep slow speed when holding the module.		<ol style="list-style-type: none"> <li>1. Box transportation needs to keep horizontal or tilted to the direction of forklift.</li> <li>2. The vertical surface of the forklift arm should be smooth and there are no something that sticks out.</li> </ol>

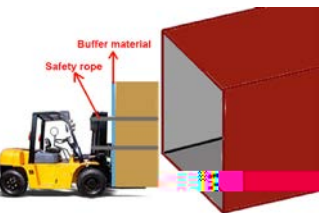
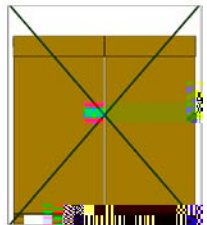
## 2. Vertical - container loading

S/N	Operating Procedure	Photo	Control Point
1	If the container is on the ground, the module can be unloading directly. (It is recommended to secure the assembly to the forklift with a safety rope and the two sides of the forklift are not allowed people remain.)		<p>If the container is not full the people need to cut the bandage when unloading (If the container is full the bandage is none).</p> 
2	If the container is on the flatbed trailer, the module need a landing platform when unloading.		<ol style="list-style-type: none"> <li>1. Before the forklift operate, add some buffer articles at the forklift arm to avoid damaging the module.</li> <li>2. Box transportation needs to keep horizontal or tilted to the direction of forklift.</li> <li>3. The vertical surface of the forklift arm should be smooth and there are no something that sticks out.</li> </ol>

4. Start from the short side of the packing box, reduce modules that are broken.
5. When second transportation, a special person should be command to carry, and it is prohibited to damage the packing box.
6. During operation, the forklift truck should not hit the pallet including the pallet wooden pier.

Figure 1

Figure 2

Figure 3

Figure 4

Figure 5

Figure 6

S/N	Operating Procedure	Control Point
1	Cut off the straps, remove the top package down and hold on flat floor as shown in figure 1.	
2	Cut the two longitudinal straps, then carefully cut and remove the cardboard of one short side of the box, as shown in figure 2.	For the safety of operation, operators should wear anti-cutting gloves and other labor protection supplies

1	Cut off the straps, remove the top package down and hold on flat floor, as shown in figure 1.	
2	Cut the two longitudinal straps, then carefully cut and remove the cardboard of one short side of the box, as shown in figure 2.	For the safety of operation, operators should wear anti-cutting gloves and other labor protection supplies. Pay attention to not damage the modules during the cutting process.
3	Cut the cardboard, then cut the inner straps around the modules, as showed in figure 3.	
4	Pull slowly out the modules from the back side of the module, then carry one module with two people as showed in figure 4. When take off the last eight modules, the outermost module must be slanted to lean on the other modules (If not may result in hidden cracks or damage when the module tilted).	
5	Package could be put on the place that the tilt angle is not more than 17 degrees. When unpacking on non-horizontal place, measures should be needed to protect modules, as showed in figure 5.	
Note	If there are modules left after unpacking, please lay them flat and repack them. For details on the storage of scattered components, see the following page.	

#### 4. Suitable for 182 double glass modules

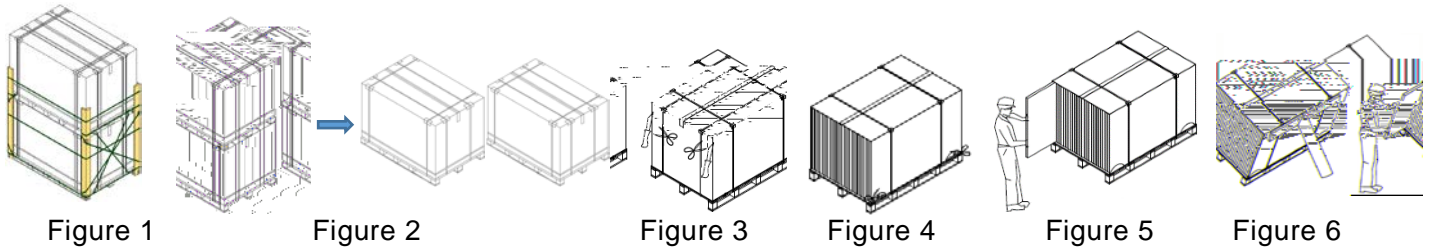

S/N	Operating Procedure	Control Point
1	Cut the packing belt on the outer side of the wooden support and gently remove the wooden support, as shown in figure 1.	
2	Cut off the straps, remove the top package down and hold on flat floor, as shown in figure 2.	
3	Cut the two longitudinal straps, then carefully cut and remove the cardboard of one short side of the box, as shown in figure 3.	For the safety of operation, operators should wear anti-cutting gloves and other labor protection supplies. Pay attention to not damage the modules during the cutting process.
4	Cut the cardboard, then cut the inner straps around the modules, as showed in figure 4.	

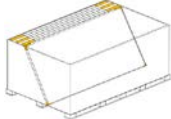
5	Pull slowly out the modules from the back side of the module, then carry one module with two people as showed in figure 5. When take off the last eight modules, the outermost module must be slanted to lean on the other modules (If not may result in hidden cracks or damage when the module tilted).	
6	Package could be put on the place that the tilt angle is not more than 17 degrees. When unpacking on non-horizontal place, measures should be needed to protect modules, as showed in figure 6.	
Note	If there are modules left after unpacking, please lay them flat and repack them. For details on the storage of scattered components, see the following page.	

5. Suitable for 210 single and double glass modules

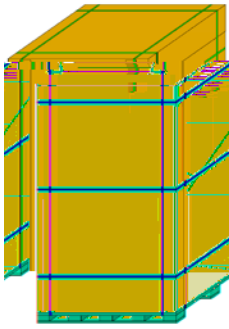

Figure 1



Figure 3



Figure 4

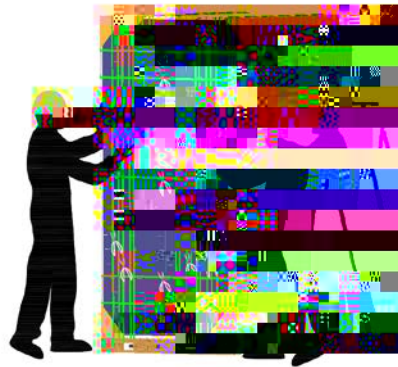

Figure 5

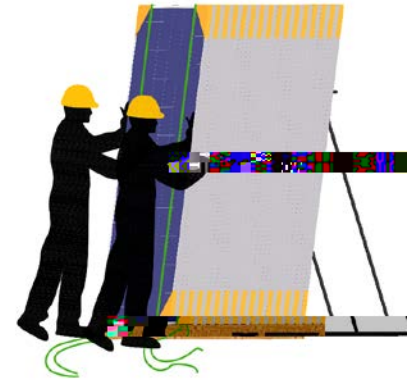

Figure 6



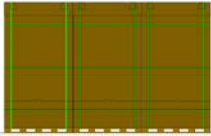
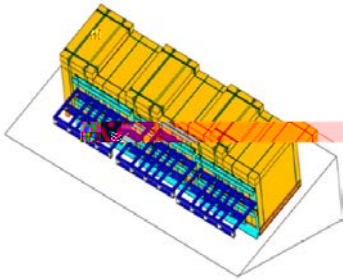



Figure 7

Figure 8

S/N	Operating Procedure	Control Point
1	Cut the packing belt on the outer side of the package box, as shown in figure 1.	For the safety of operation, operators should wear anti-cutting gloves and other labor protection supplies.
2	Remove the top cover and the packing case, as shown in figure 2.	
3	Insert the support bracket into the bottom of the tray from the module glass or back surface, as shown in figure 3.	
4	Pull out the 4 stop rods from both sides of the tray, as shown in figure 4.	
5	Cut and remove the inner transverse packing belt around the modules as shown in figure 5.	Pay attention to not damage the modules during the cutting process.
6	When there are 1-2 longitudinal packing belts remaining, slowly push the modules to tilt towards the support bracket, as shown in figure 6.	
7	Cut the remaining packing belts so that the modules lean against the support bracket, as shown in figure 7.	
8	Move the modules in sequence, as shown in figure 8.	
9	Package should be placed on level ground. When unpacking on non-horizontal place, measures should be needed to protect modules.	

Note  
 If there are modules left after unpacking, please lay them flat and repack them.  
 For details on the storage of scattered modules, see the following page.

1	The module would be best set on the flat floor, stand side by side and place neatly.	 	To same color and current modules, try to make sure that they are placed together for easy management.
2	<p>1. If the ground is not flat or the slope is small, the stacked package must be break down, the short part of carton is facing down, stand side by side and place neatly.</p> <p>2. Module are not allowed to place on steep ground.</p> <p>3. When second transportation, a special person should be command to carry, and it is prohibited to damage the packing box.</p>		<p>The pallet should be pulled firmly as following.</p> 
3	The module should be protect when raining or wet, which wrapped by waterproof.		<p>It should be protected by waterproof whether above two methods.</p> <p>If the installation is not performed after the arrival of the modules, the packaging box must be kept in a dry state and moved indoors. If the packaging box is found to be wet, it is recommended to dry the modules and replace the packaging box.</p>

#### 7.4 Storage for scattered modules

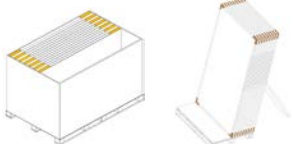
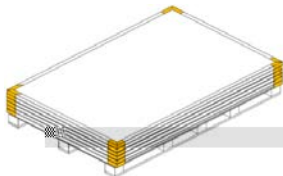
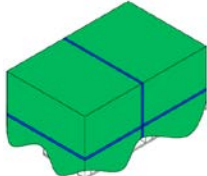
S/N	Operating Procedure	Photo	Control Point
1	If unpacked modules do not installed completely.		It can not remain in the box for long time, if it is necessary to storage the unpacked modules, we suggest the following method.
2	Place the modules on the pallet.		<ol style="list-style-type: none"> <li>1. The pallet need to put on the flat ground.</li> <li>2. The glass of first module need to face upward, it need to face down from second module.</li> <li>3. It can not more than 10 Pcs/pallet totally.</li> <li>4. It is forbidden that carry module by cable of junction box.</li> <li>5. The modules should be stacked neatly, avoid the glass blasting because of dislocation.</li> <li>6. Do not allowed to carry modules in the this case.</li> <li>7. It is not allowed two or more adjacent modules which have no corner protection</li> </ol>
3	Modules should be wrapped by waterproof.		If the installation is not performed after the arrival of the modules, the packaging box must be kept in a dry state and moved indoors. If the packaging box is found to be wet, it is recommended to dry the modules and replace the packaging box.